



## Description

### JMT N-channel Enhancement Mode Power MOSFET

#### Features

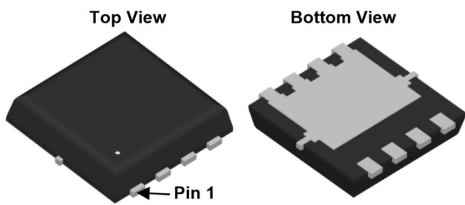
- 40V,70A  
 $R_{DS(ON)} < 5.6m\Omega @ V_{GS} = 10V$   
 $R_{DS(ON)} < 8.7m\Omega @ V_{GS} = 4.5V$
- Lead free and Green Device Available
- Excellent  $R_{DS(ON)}$  and Low Gate Charge
- Lead free product is acquired

#### Application

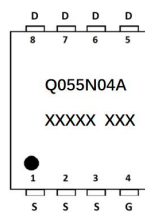
- Load Switch
- PWM Application
- Power management



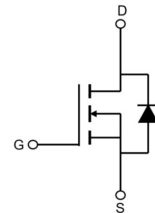
*100% UIS TESTED!*  
*100%  $\Delta V_{ds}$  TESTED!*



PDFN3x3-8L



Marking and pin Assignment



Schematic Diagram

## Package Marking and Ordering Information

| Device Marking | Device      | OUTLINE | Device Package | Reel Size | Reel (PCS) | Per Carton (PCS) |
|----------------|-------------|---------|----------------|-----------|------------|------------------|
| Q055N04A       | JMTQ055N04A | TAPING  | PDFN3x3-8L     | 13inch    | 5000       | 50000            |

## Absolute Maximum Ratings ( $T_C=25^\circ C$ unless otherwise specified)

| Symbol          | Parameter                                       | Max.                | Units        |
|-----------------|---|---------------------|--------------|
| $V_{DSS}$       | Drain-Source Voltage                            | 40                  | V            |
| $V_{GSS}$       | Gate-Source Voltage                             | $\pm 20$            | V            |
| $I_D$           | Continuous Drain Current                        | $T_C = 25^\circ C$  | 70           |
|                 |   | $T_C = 100^\circ C$ | 46           |
| $I_{DM}$        | Pulsed Drain Current <sup>note1</sup>           | 280                 | A            |
| $E_{AS}$        | Single Pulsed Avalanche Energy <sup>note2</sup> | 78                  | mJ           |
| $P_D$           | Power Dissipation                               | $T_C = 25^\circ C$  | 47           |
| $R_{\theta JC}$ | Thermal Resistance, Junction to Case            | 2.7                 | $^\circ C/W$ |
| $T_J, T_{STG}$  | Operating and Storage Temperature Range         | -55 to +150         | $^\circ C$   |



## Electrical Characteristics (T<sub>J</sub>=25°C unless otherwise specified)

| Symbol  | Parameter   | Test Condition  | Min. | Typ. | Max. | Units |
|---|---|---|------|------|------|-------|
| <b>Off Characteristic</b>                                     |   |   |      |      |      |       |
| V <sub>(BR)DSS</sub>  | Drain-Source Breakdown Voltage                            | V <sub>GS</sub> =0V, I <sub>D</sub> =250μA  | 40   | -    | -    | V     |
| I <sub>DSS</sub>  | Zero Gate Voltage Drain Current                           | V <sub>DS</sub> =40V, V <sub>GS</sub> =0V,  | -    | -    | 1.0  | μA    |
| I <sub>GSS</sub>  | Gate to Body Leakage Current                              | V <sub>DS</sub> =0V, V <sub>GS</sub> =±20V  | -    | -    | ±100 | nA    |
| <b>On Characteristics</b>                                     |   |   |      |      |      |       |
| V <sub>GS(th)</sub>   | Gate Threshold Voltage                                    | V <sub>DS</sub> =V <sub>GS</sub> , I <sub>D</sub> =250μA  | 1    | 1.5  | 2.5  | V     |
| R <sub>DS(on)</sub>   | Static Drain-Source on-Resistance<br><small>note3</small> | V <sub>GS</sub> =10V, I <sub>D</sub> =30A   | -    | 4.3  | 5.6  | mΩ    |
|   |   | V <sub>GS</sub> =4.5V, I <sub>D</sub> =20A  | -    | 6.2  | 8.7  |       |
| <b>Dynamic Characteristics</b>                                |   |   |      |      |      |       |
| C <sub>iss</sub>  | Input Capacitance   | V <sub>DS</sub> =20V, V <sub>GS</sub> =0V,<br>f=1.0MHz  | -    | 3671 | -    | pF    |
| C <sub>oss</sub>  | Output Capacitance  |   | -    | 296  | -    | pF    |
| C <sub>rss</sub>  | Reverse Transfer Capacitance                              |   | -    | 239  | -    | pF    |
| Q <sub>g</sub>  | Total Gate Charge   | V <sub>DS</sub> =20V, I <sub>D</sub> =30A,<br>V <sub>GS</sub> =10V  | -    | 57   | -    | nC    |
| Q <sub>gs</sub>   | Gate-Source Charge  |   | -    | 9    | -    | nC    |
| Q <sub>gd</sub>   | Gate-Drain("Miller") Charge                               |   | -    | 11   | -    | nC    |
| <b>Switching Characteristics</b>                              |   |   |      |      |      |       |
| t <sub>d(on)</sub>  | Turn-on Delay Time  | V <sub>DD</sub> =20V, I <sub>D</sub> =30A,<br>R <sub>L</sub> =1Ω, R <sub>GEN</sub> =3Ω,<br>V <sub>GS</sub> =10V | -    | 8    | -    | ns    |
| t <sub>r</sub>  | Turn-on Rise Time   |   | -    | 18   | -    | ns    |
| t <sub>d(off)</sub>   | Turn-off Delay Time                                       |   | -    | 24   | -    | ns    |
| t <sub>f</sub>  | Turn-off Fall Time  |   | -    | 14   | -    | ns    |
| <b>Drain-Source Diode Characteristics and Maximum Ratings</b> |   |   |      |      |      |       |
| I <sub>S</sub>  | Maximum Continuous Drain to Source Diode Forward Current  |   | -    | -    | 70   | A     |
| I <sub>SM</sub>   | Maximum Pulsed Drain to Source Diode Forward Current      |   | -    | -    | 280  | A     |
| V <sub>SD</sub>   | Drain to Source Diode Forward Voltage                     | V <sub>GS</sub> =0V, I <sub>S</sub> =30A  | -    | -    | 1.2  | V     |
| t <sub>rr</sub>   | Body Diode Reverse Recovery Time                          | T <sub>J</sub> =25°C,<br>I <sub>F</sub> =20A, dI/dt=100A/μs   | -    | 22   | -    | ns    |
| Q <sub>rr</sub>   | Body Diode Reverse Recovery Charge                        |   | -    | 11   | -    | nC    |

Notes:1. Repetitive Rating: Pulse Width Limited by Maximum Junction Temperature

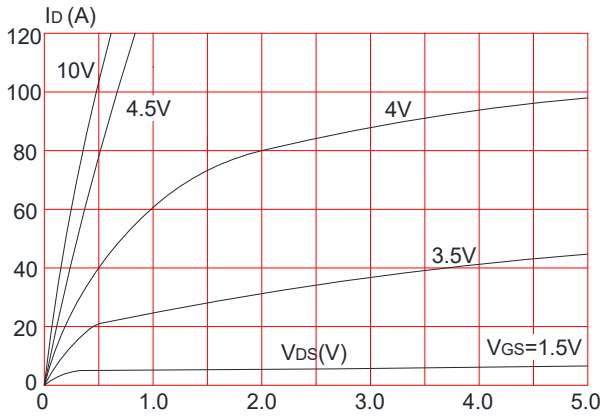
2. EAS condition: T<sub>J</sub>=25°C, V<sub>DD</sub>=20V, V<sub>G</sub>=10V, R<sub>G</sub>=25Ω, L=0.5mH, I<sub>AS</sub>=17.7A

3. Pulse Test: Pulse Width≤300μs, Duty Cycle≤0.5%

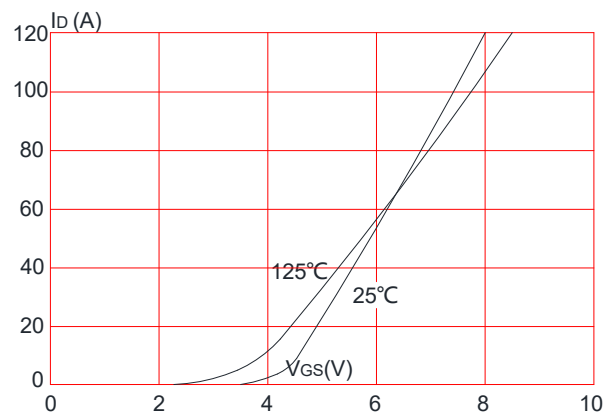


## Typical Performance Characteristics

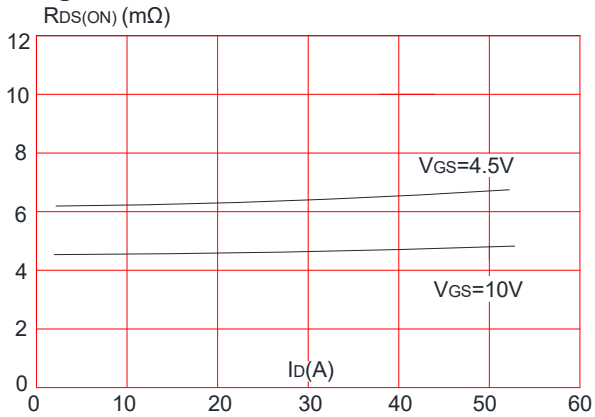
**Figure 1: Output Characteristics**



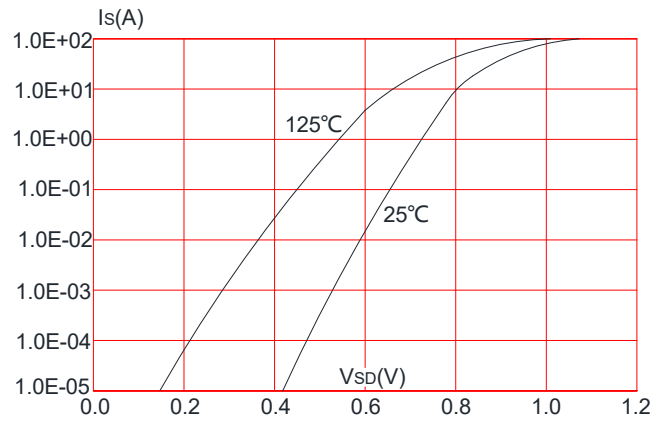
**Figure 2: Typical Transfer Characteristics**



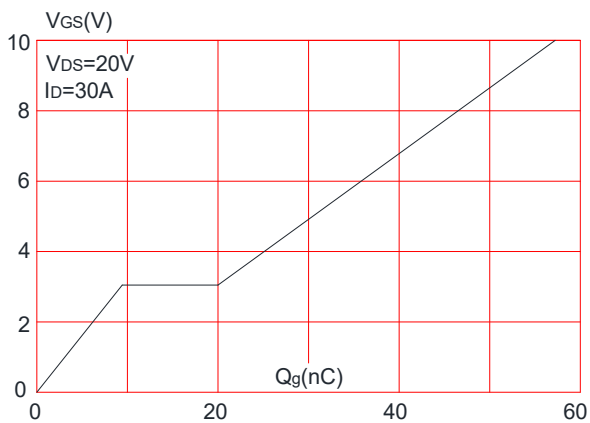
**Figure 3: On-resistance vs. Drain Current**



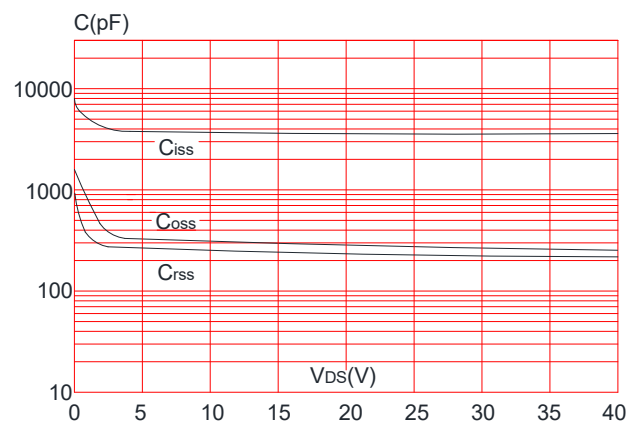
**Figure 4: Body Diode Characteristics**



**Figure 5: Gate Charge Characteristics**

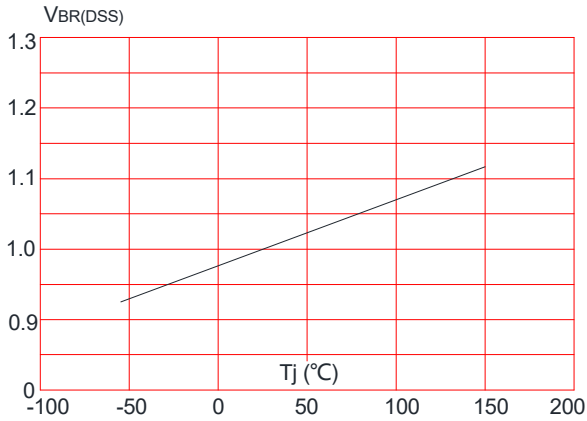


**Figure 6: Capacitance Characteristics**

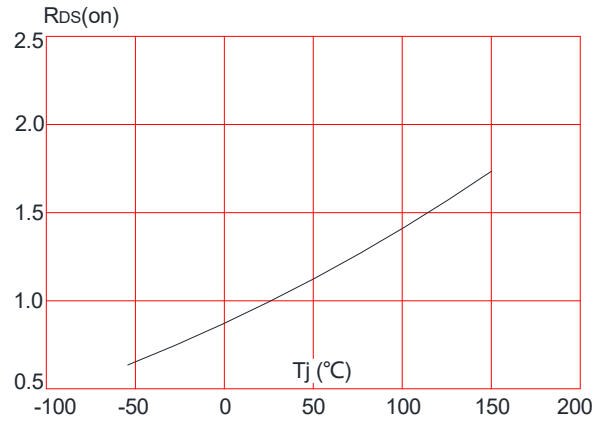




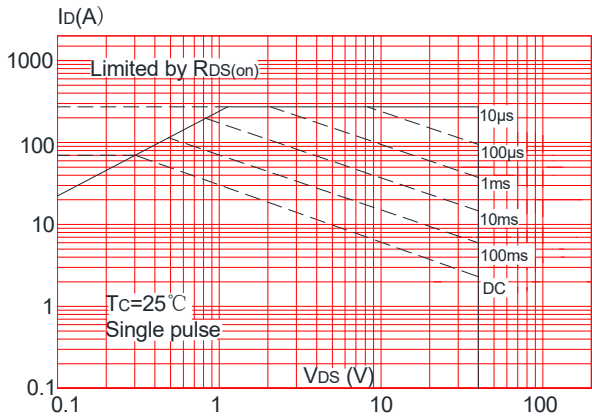
**Figure 7:** Normalized Breakdown Voltage vs. Junction Temperature



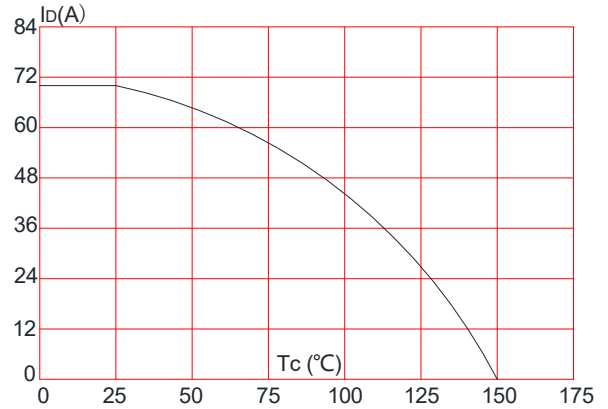
**Figure 8:** Normalized on Resistance vs. Junction Temperature



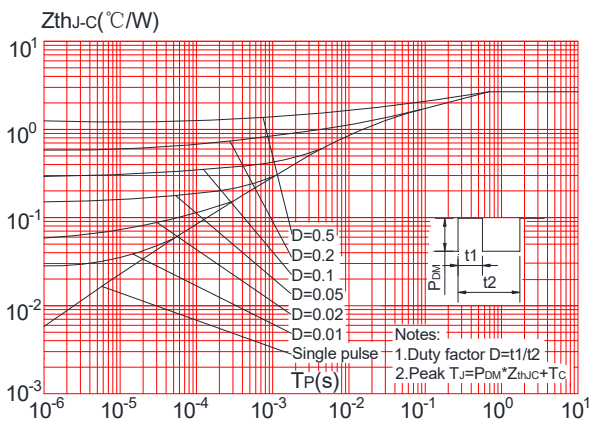
**Figure 9:** Maximum Safe Operating Area



**Figure 10:** Maximum Continuous Drain Current vs. Case Temperature



**Figure.11:** Maximum Effective Transient Thermal Impedance, Junction-to-Case



## Test Circuit



Figure1:Gate Charge Test Circuit & Waveform

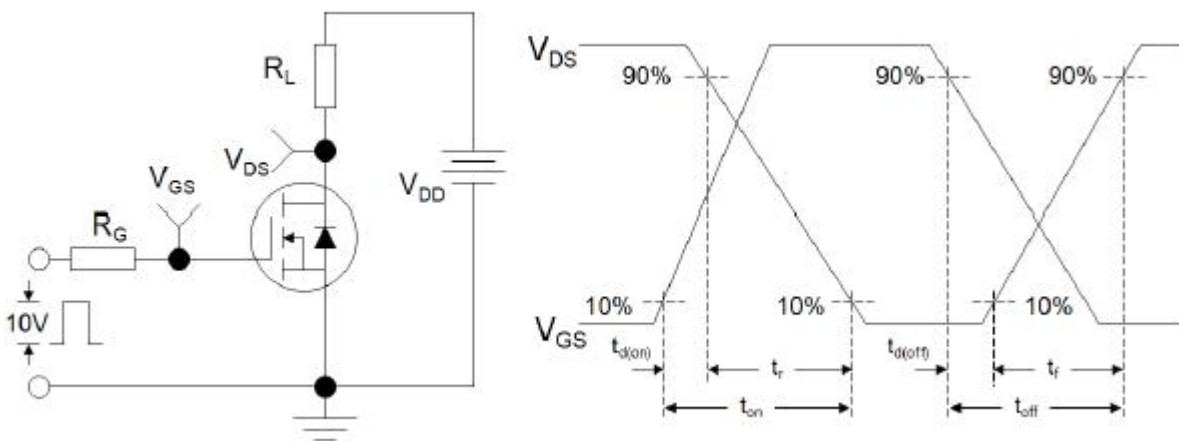


Figure 2: Resistive Switching Test Circuit & Waveforms

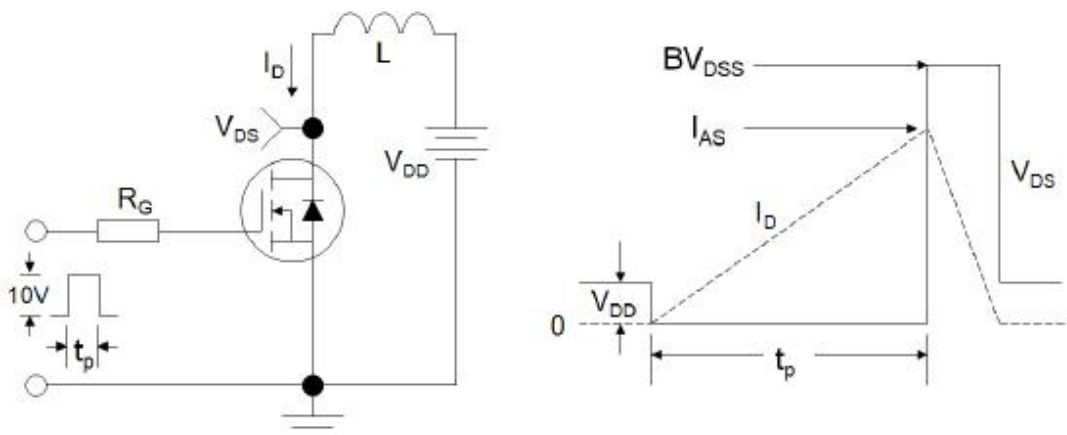
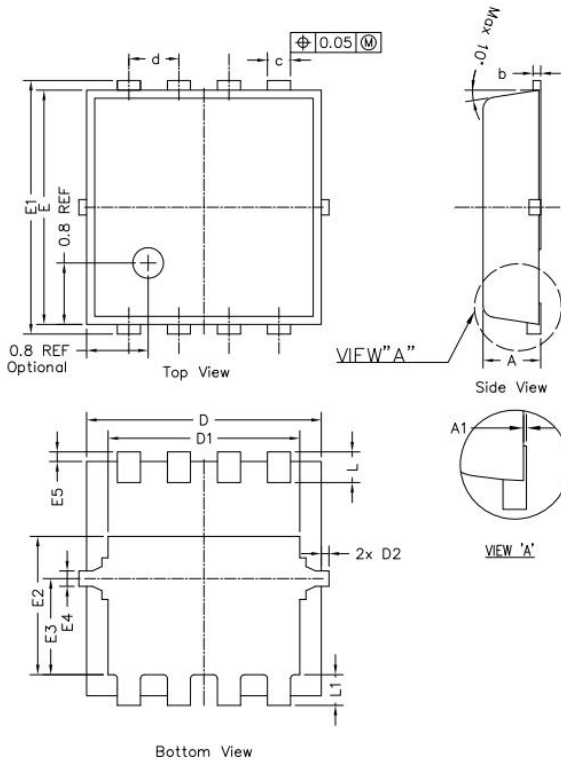


Figure 3:Unclamped Inductive Switching Test Circuit & Waveforms



## Package Mechanical Data-PDFN3x3-8L



| SYMBOLS | DIMENSION IN MM |       |       | DIMENSION IN INCHES |       |       |
|---------|-----------------|-------|-------|---------------------|-------|-------|
|         | MIN             | NOM   | MAX   | MIN                 | NOM   | MAX   |
| A       | 0.700           | 0.750 | 0.800 | 0.028               | 0.030 | 0.031 |
| A1      | ---             | ---   | 0.050 | ----                | ----  | 0.002 |
| b       | 0.144           | 0.152 | 0.202 | 0.006               | 0.006 | 0.008 |
| c       | 0.250           | 0.300 | 0.350 | 0.010               | 0.012 | 0.014 |
| d       | 0.65 BSC        |       |       | 0.026 BSC           |       |       |
| D       | 2.950           | 3.050 | 3.150 | 0.116               | 0.120 | 0.124 |
| D1      | 2.390           | 2.490 | 2.590 | 0.094               | 0.098 | 0.102 |
| D2      | ---             | ---   | 0.125 | ---                 | ---   | 0.005 |
| E       | 2.950           | 3.050 | 3.150 | 0.116               | 0.120 | 0.124 |
| E1      | 3.200           | 3.300 | 3.400 | 0.126               | 0.130 | 0.134 |
| E2      | 1.700           | 1.800 | 1.900 | 0.067               | 0.071 | 0.075 |
| E3      | 1.150           | 1.250 | 1.350 | 0.045               | 0.049 | 0.053 |
| E4      | 0.150           | 0.200 | 0.250 | 0.006               | 0.008 | 0.010 |
| E5      | 0.075           | 0.125 | 0.175 | 0.003               | 0.005 | 0.007 |
| L       | 0.300           | 0.400 | 0.500 | 0.01                | 0.02  | 0.02  |
| L1      | 0.300           | 0.400 | 0.500 | 0.01                | 0.02  | 0.02  |

Information furnished in this document is believed to be accurate and reliable. However, Jiangsu JieJie Microelectronics Co.,Ltd assumes no responsibility for the consequences of use without consideration for such information nor use beyond it.

Information mentioned in this document is subject to change without notice, apart from that when an agreement is signed, Jiangsu JieJie complies with the agreement.

Products and information provided in this document have no infringement of patents. Jiangsu JieJie assumes no responsibility for any infringement of other rights of third parties which may result from the use of such products and information.



is a registered trademark of Jiangsu JieJie Microelectronics Co.,Ltd.

Copyright ©2022 Jiangsu JieJie Microelectronics Co.,Ltd. Printed All rights reserved.